

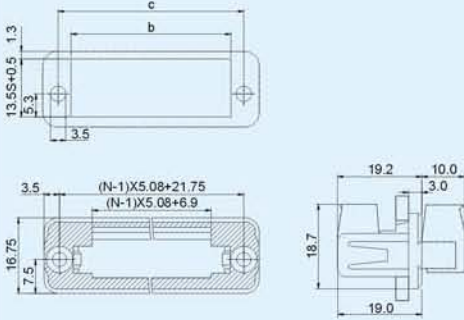

2CDG-5.08



Pitch:5.08mm;Poles:2P~24P

- **Material**
Housing : PA66,UL94V-0
- **Electrical**
Rated voltage : 300V
Rated current : 15A
Contact resistance : 20mΩ
Insulation resistance : 5000MΩ/DC1000V
Withstanding voltage: AC2000V/1Min
- **Mechanical**
Temp.Range : -40°C~+105°C

- 材质及电镀
塑件 : PA66, UL94V-0
- 电气性能
额定电压: 300V
额定电流: 15A
接触电阻: 20mΩ
绝缘电阻: 5000MΩ/DC1000V
耐电压 : AC2000V/1Min
- 机械性能
温度范围: -40°C~+105°C



2CDGA-5.0
2CDGA-5.08

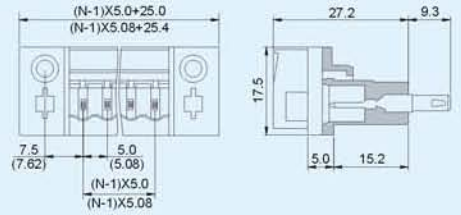

Pitch:5.0mm,5.08mm;Poles:2P~22P

- **Material**
Pin header : Brass,Tin plated
Housing : PA66,UL94V-0
- **Electrical**
Rated voltage : 300V
Rated current : 15A
Contact resistance : 20mΩ
Insulation resistance : 5000MΩ/DC1000V
Withstanding voltage: AC2000V/1Min
- **Mechanical**
Temp.Range : -40°C~+105°C

- 材质及电镀
焊针 : 黄铜, 镀锡
塑件 : PA66, UL94V-0
- 电气性能
额定电压: 300V
额定电流: 15A
接触电阻: 20mΩ
绝缘电阻: 5000MΩ/DC1000V
耐电压 : AC2000V/1Min
- 机械性能
温度范围: -40°C~+105°C

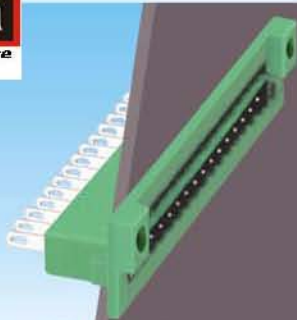

2CDGB-5.0
2CDGB-5.08

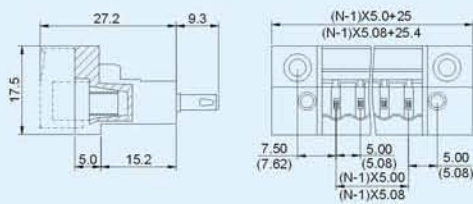

Pitch: 5.0mm, 5.08mm; Poles: 2P~22P

● **Material**

Pin header : Brass, Tin plated
Housing : PA66, UL94V-0

● **Electrical**

Rated voltage : 300V
Rated current : 15A
Contact resistance : 20mΩ
Insulation resistance : 5000MΩ/DC1000V
Withstanding voltage: AC2000V/1Min

● **Mechanical**

Temp. Range : -40°C~+105°C

● **材质及电镀**

焊针 : 黄铜, 镀锡
塑件 : PA66, UL94V-0

● **电气性能**

额定电压: 300V
额定电流: 15A
接触电阻: 20mΩ
绝缘电阻: 5000MΩ/DC1000V
耐电压 : AC2000V/1Min

● **机械性能**

温度范围: -40°C~+105°C



2CDGV-5.08

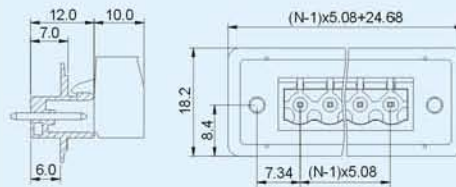

Pitch: 5.08mm; Poles: 2P~24P

● **Material**

Pin header : Brass, Tin plated
Housing : PA66, UL94V-0

● **Electrical**

Rated voltage : 300V
Rated current : 15A
Contact resistance : 20mΩ
Insulation resistance : 5000MΩ/DC1000V
Withstanding voltage: AC2000V/1Min

● **Mechanical**

Temp. Range : -40°C~+105°C

● **材质及电镀**

焊针 : 黄铜, 镀锡
塑件 : PA66, UL94V-0

● **电气性能**

额定电压: 300V
额定电流: 15A
接触电阻: 20mΩ
绝缘电阻: 5000MΩ/DC1000V
耐电压 : AC2000V/1Min

● **机械性能**

温度范围: -40°C~+105°C



2CDGVM-5.08

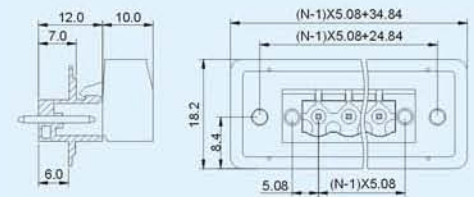

Pitch: 5.08mm; Poles: 2P~22P

● **Material**

Pin header : Brass, Tin plated
Housing : PA66, UL94V-0
Nut : M2.5, Brass

● **Electrical**

Rated voltage : 300V
Rated current : 15A
Contact resistance : 20mΩ
Insulation resistance : 5000MΩ/DC1000V
Withstanding voltage: AC2000V/1Min

● **Mechanical**

Temp. Range : -40°C~+105°C

● **材质及电镀**

焊针 : 黄铜, 镀锡
塑件 : PA66, UL94V-0
螺母 : M2.5, 黄铜

● **电气性能**

额定电压: 300V
额定电流: 15A
接触电阻: 20mΩ
绝缘电阻: 5000MΩ/DC1000V
耐电压 : AC2000V/1Min

● **机械性能**

温度范围: -40°C~+105°C

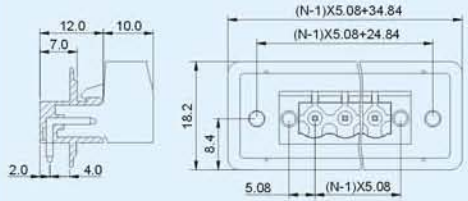
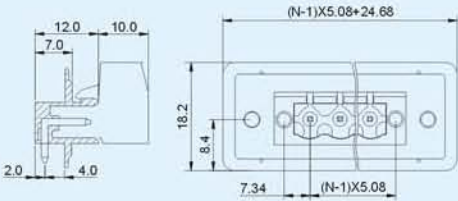

Pitch:5.08mm;Poles:2P~24P

Pitch:5.08mm;Poles:2P~22P

● **Material**

Pin header : Brass, Tin plated
Housing : PA66, UL94V-0

● **Material**

Pin header : Brass, Tin plated
Housing : PA66, UL94V-0
Nut : M2.5, Brass

● **Electrical**

Rated voltage : 300V
Rated current : 15A
Contact resistance : 20mΩ
Insulation resistance : 5000MΩ/DC1000V
Withstanding voltage: AC2000V/1Min

● **Electrical**

Rated voltage : 300V
Rated current : 15A
Contact resistance : 20mΩ
Insulation resistance : 5000MΩ/DC1000V
Withstanding voltage: AC2000V/1Min

● **Mechanical**

Temp.Range : -40°C~+105°C

● **Mechanical**

Temp.Range : -40°C~+105°C

● **材质及电镀**

焊针 : 黄铜, 镀锡
塑件 : PA66, UL94V-0

● **材质及电镀**

焊针 : 黄铜, 镀锡
塑件 : PA66, UL94V-0
螺母 : M2.5, 黄铜

● **电气性能**

额定电压: 300V
额定电流: 15A
接触电阻: 20mΩ
绝缘电阻: 5000MΩ/DC1000V
耐电压 : AC2000V/1Min

● **电气性能**

额定电压: 300V
额定电流: 15A
接触电阻: 20mΩ
绝缘电阻: 5000MΩ/DC1000V
耐电压 : AC2000V/1Min

● **机械性能**

温度范围: -40°C~+105°C

● **机械性能**

温度范围: -40°C~+105°C